

# CIRCULATION UNIT

## MIXING FUNCTION, SERIES GRA300



GRA311

### PRODUCT DESCRIPTION

The ESBE series GRA300 is a circulation mixing unit which is intended for heating circulations where the outstanding flow and temperature control are required. Equipped with two shut-off valves with thermometers, check valve, high class insulation shell and high efficiency circulation pump.

The GRA300 is delivered with the 3-way rotary progressive mixing valve and actuator. The Circulation Mixing Unit ensures best regulation performances independent from flow rate and low oversizing risk thanks to progressive valve characteristic, as well as the working possibility with most controllers available on the market.

### SERVICE AND MAINTENANCE

The circulation unit does not require any specific maintenance under normal conditions.

### KEY BENEFITS

- Outstanding flow control thanks to the progressive characteristic of the valve
- Ready to use with most controllers available on the market
- High class insulation shell
- Compact design
- "Quick fit" connection between Valve and Actuator

### PRODUCT ASSORTMENT

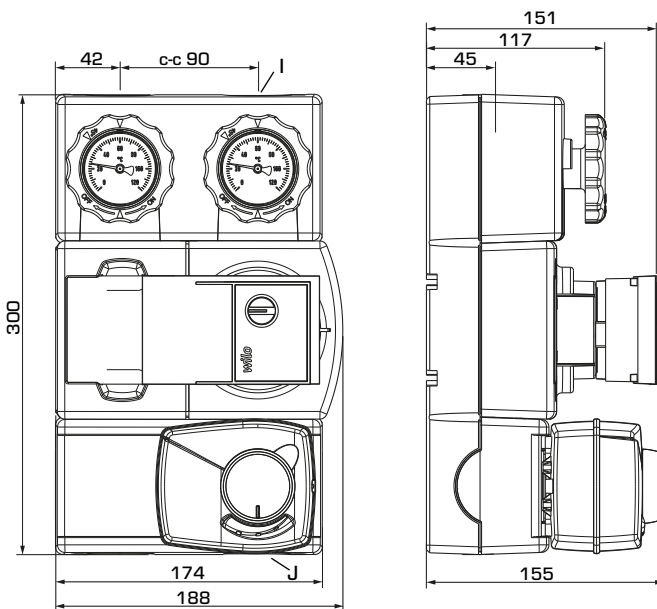

GRA311

### SERIES GRA300

Art. No.	Reference	DN	Pump	Connections		Weight [kg]	Note
				I	J		
61043100	GRA311	20	Wilo 15/7,5	G 3/4"	G 1"	4,5	

# CIRCULATION UNIT

## MIXING FUNCTION, SERIES GRA300

### TECHNICAL DATA

 Visit [esbe.eu](http://esbe.eu) for further detailed information.

#### The Circulation unit, in general:

Pressure class: \_\_\_\_\_ PN 6  
 Media temperature: \_\_\_\_\_ max. +110°C  
 \_\_\_\_\_ min. 0°C  
 Ambient temperature: \_\_\_\_\_ max. +50°C  
 \_\_\_\_\_ min. 0°C  
 Working pressure: \_\_\_\_\_ 0,6 MPa (6 bar)  
 Connections, \_\_\_\_\_ Internal thread (G), ISO 228/1  
 \_\_\_\_\_ External thread (G), ISO 228/1  
 Insulation: \_\_\_\_\_ EPP  $\lambda$  0,036 W/mK  
 Media: \_\_\_\_\_ Heating water (in accordance with VDI2035)  
 \_\_\_\_\_ Water / Glycol mixtures, max. 50%  
 \_\_\_\_\_ (above 20% admixture, the pump data must be checked)  
 \_\_\_\_\_ Water / Ethanol mixtures, max. 28%

#### Material, in contact with water:

Components of: \_\_\_\_\_ Steel, Cast iron, Brass  
 Sealing material of: \_\_\_\_\_ PTFE, Aramid fibre, EPDM

#### EEI (Energy Efficiency Index),

Wilco circulation pump: \_\_\_\_\_ <0,21

#### Conformities and certificates:

 LVD 2014/35/EU  ErP 2009/125/EU  
 EMC 2014/30/EU  ErP 2015  
 RoHS 2011/65/EU  ErEV 2014  
 PED 2014/68/EU, article 4.3

#### The integrated mixing valve:

Max. differential pressure drop: \_\_\_\_\_ 100 kPa (1 bar)  
 Close off pressure: \_\_\_\_\_ 200 kPa (2 bar)  
 Leakrate in % of flow\*: \_\_\_\_\_ < 0,5%  
 \* Differential pressure 100kPa (1 bar)

#### VALVE CHARACTERISTICS

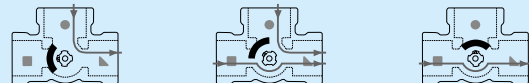
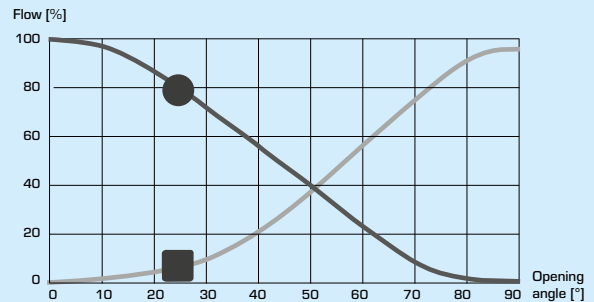

#### The integrated actuator:

Actuator type: \_\_\_\_\_ ARA661 Quick fit  
 Control signal: \_\_\_\_\_ 3-point  
 Power supply: \_\_\_\_\_ 230 ± 10% V AC, 50 Hz  
 Power consumption: \_\_\_\_\_ 5 VA  
 Running time 90°: \_\_\_\_\_ 120s  
 Enclosure rating: \_\_\_\_\_ IP41  
 Protection class: \_\_\_\_\_ II

#### ACTUATOR WIRING\*

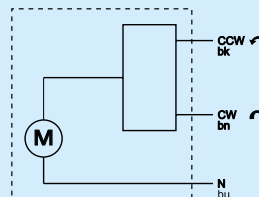

#### The integrated circulation pump:

Type: \_\_\_\_\_ Wilo RSTG 15/7.5  
 Power supply: \_\_\_\_\_ 230 ± 10% V AC, 50/60 Hz  
 Cable length: \_\_\_\_\_ 3m  
 Power consumption: \_\_\_\_\_ 4-75 W  
 Enclosure rating: \_\_\_\_\_ IP X4D  
 Insulation class: \_\_\_\_\_ F  
 EEI (Energy Efficiency Index): \_\_\_\_\_ <0,21

#### PUMP WIRING\*

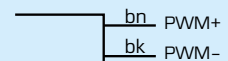
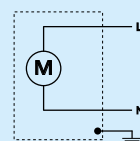

Pumpspeed could be controlled by PWM signal

\* The actuator and circulation pump should be preceded by a multi-pole contact breaker in the fixed installation.

# CIRCULATION UNIT

## MIXING FUNCTION, SERIES GRA300

### DIMENSIONING, PUMP CAPACITY DIAGRAM

**Example:** Start with the heating demand of heating circuit (e.g. 25 kW) and move horizontally to the right in the diagram to the  $\Delta t = 15^\circ\text{C}$  (temperature difference between flow and return of the heating circuit). Next go up and find working flow point and read the available pressure of the pump on the left -  $\Delta p = 62 \text{ kPa}$ .

### SERIES GRA300 –available pressure

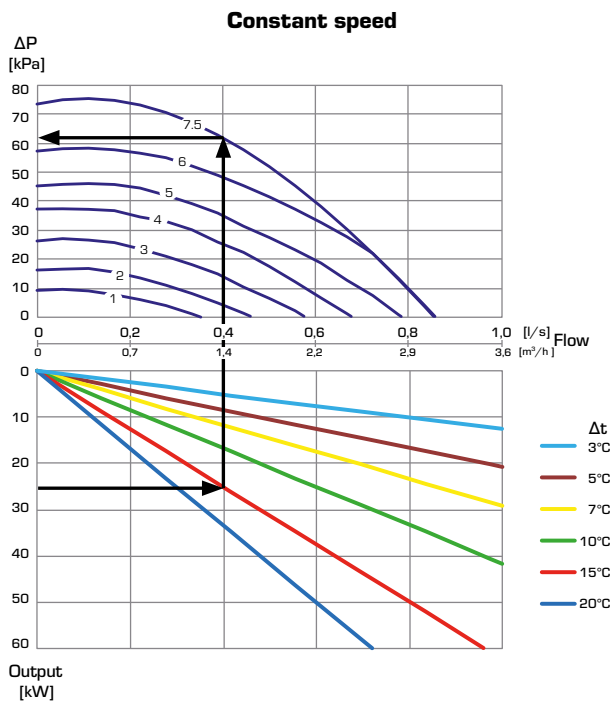

### SERIES GRA300 –available pressure

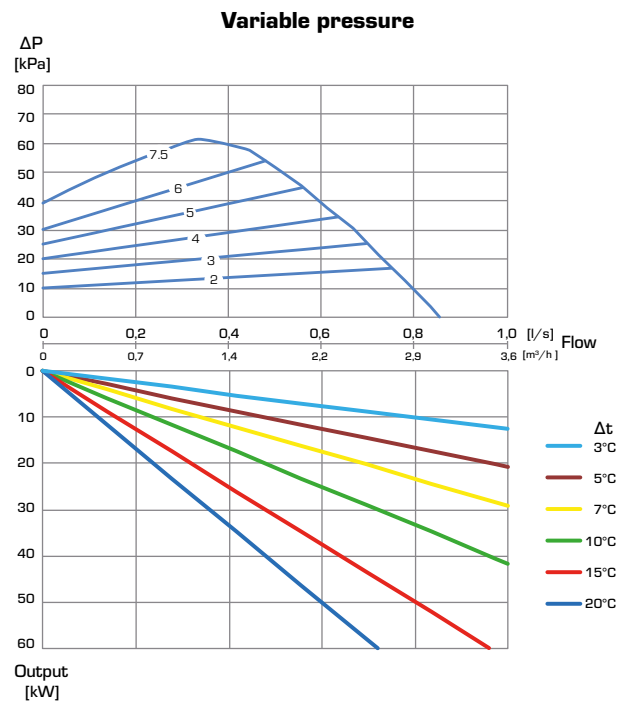

### INSTALLATION EXAMPLES

