



**SERIES VRG120**



Mtrl.nr: 9814 10 38 • Ritn.nr: 7726 vers. A • Rev. 1805



Series VRG121  
Series VRG122

PED 2014/68/EU, article 4.3

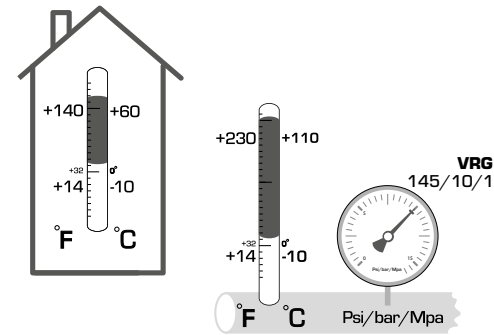

**1**

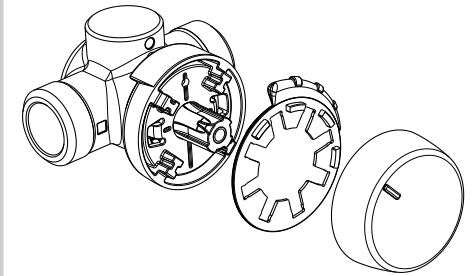

**i**

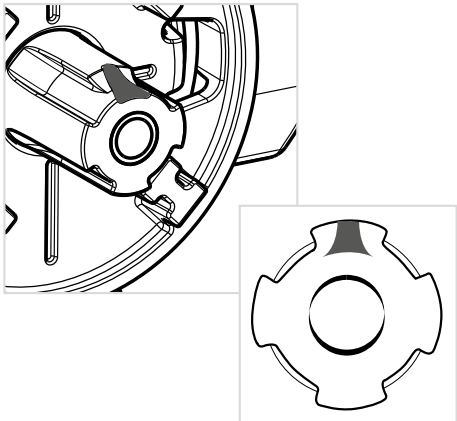

**i**

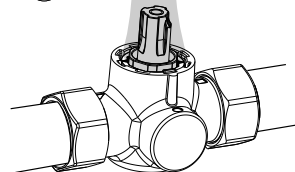
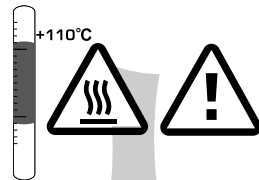
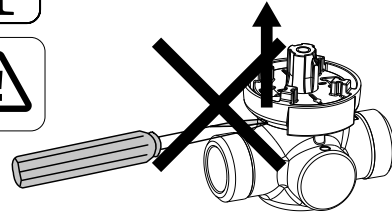

**2**

**a**

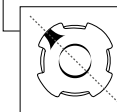
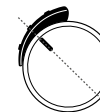
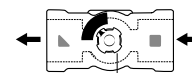
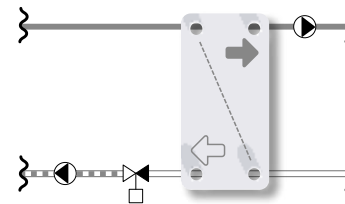

**b**

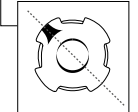
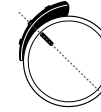
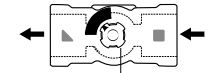
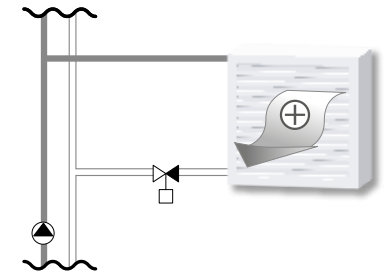

Piping Schematics are General Representations



[http://www.esbe.eu/global/en/  
products/rotary-valves](http://www.esbe.eu/global/en/products/rotary-valves)