

LINEAR MOTORIZED VALVES

# CONTROL VALVE PN16 SERIES SERIE VLA100

ESBE control valves series VLA100 are 2-way and 3-way internal threaded valves for PN16, DN 15-50.



VLA121  
Internal thread PN16

VLA131  
Internal thread PN16

### MEDIA

These valves can handle the following types of media:

- Hot and cold water.
- Water with antifreeze additives such as glycol.

If the valve is used for media at temperatures below 0°C (32°F), it should be equipped with a stem heater in order to prevent ice formation on the valve stem.

### OPTION

Adaptor kit \_\_\_\_\_ Siemens SQX, Art. No. 2600 07 00

### CONTROL VALVE DESIGNED FOR

- Heating
- Comfort Cooling
- Floor heating
- Solar heating
- Ventilation
- District Heating
- District Cooling

### SUITABLE ACTUATORS

- Series ALB140
- Series ALF13x
- Series ALF26x
- Series ALF36x

### TECHNICAL DATA

Type: \_\_\_\_\_ 2- and 3-way plug valve  
 Pressure class: \_\_\_\_\_ PN 16  
 Flow characteristic A-AB: \_\_\_\_\_ EGM  
 Flow characteristic B-AB: \_\_\_\_\_ Complementary  
 Stroke: \_\_\_\_\_ 20 mm  
 Rangeability  $K_v/K_v^{min}$ : \_\_\_\_\_ see graph  
 Leakrate A-AB: \_\_\_\_\_ Tight sealing  
 Leakrate B-AB: \_\_\_\_\_ Tight sealing  
 $\Delta P_{max}$ : \_\_\_\_\_ see graph  
 Media temperature: \_\_\_\_\_ max. +130°C  
 \_\_\_\_\_ min. -20°C  
 Connection: \_\_\_\_\_ Internal thread, EN 10226-1

#### Material

Body: \_\_\_\_\_ Nodular iron EN-JS 1030  
 Stem: \_\_\_\_\_ Stainless steel SS 2346  
 Plug: \_\_\_\_\_ Brass CW602N  
 Seat: \_\_\_\_\_ Nodular iron EN-JS 1030  
 Blind plug: \_\_\_\_\_ Brass CW602N  
 Seat seal: \_\_\_\_\_ EPDM  
 Packing box seal: \_\_\_\_\_ PTFE/EPDM

PED 2014/68/EU, article 4.3

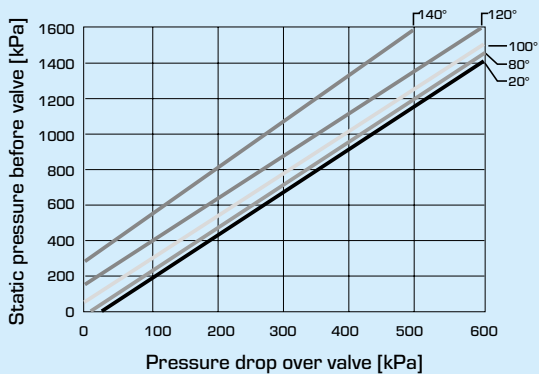

Pressure drop limit where cavitation might occur. Is dependent of valve inlet pressure and temperature of water.

### VALVE CHARACTERISTICS

2-way valves, DN15-50

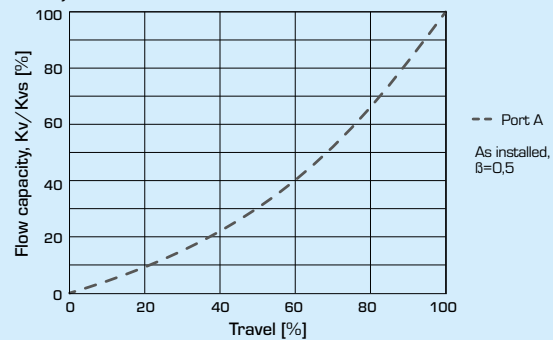

3-way valves, DN15-50

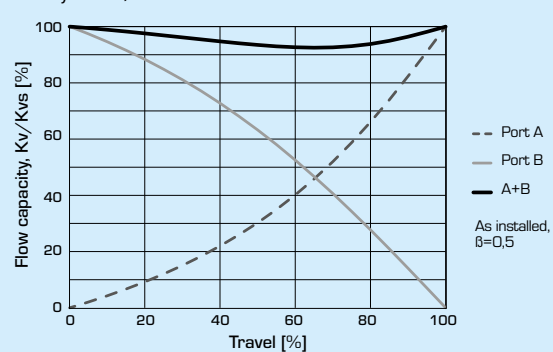

# CONTROL VALVE PN16

## SERIE SERIE VLA100

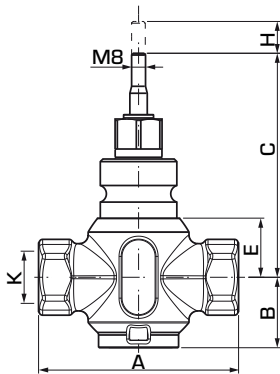

VLA121

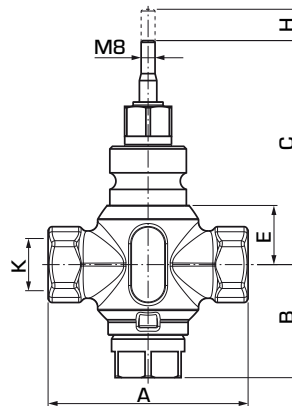

VLA131

### 2-WAY CONTROL VALVE SERIES VLA121

Art. No.	Reference	DN	Kvs *	A	B	C	E	H	K	Rangeability Kv/Kv <sup>min</sup>	Weight [kg]
21150100	VLA121	15	1.6	85	38	108	24	20	Rp 1/2"	>50	1.0
21150200			2.5								
21150300			4								
21150400	VLA121	20	6.3	100	40	115	30	20	Rp 3/4"	>50	1.2
21150500	VLA121	25	10	115	40	119	34	20	Rp 1"	>50	1.3
21150600	VLA121	32	16	130	41	120	35	20	Rp 1 1/4"	>50	1.8
21150700	VLA121	40	25	150	50	128	42	20	Rp 1 1/2"	>50	2.7
21150800	VLA121	50	38	180	59	138	53	20	Rp 2"	>50	4.2

### 3-WAY CONTROL VALVES SERIES VLA131

Art. No.	Reference	DN	Kvs *	A	B	C	E	H	K	Rangeability Kv/Kv <sup>min</sup>	Weight [kg]
21150900	VLA131	15	1.6	85	58	108	24	20	Rp 1/2"	>50	1.1
21151000			2.5								
21151100			4								
21151200	VLA131	20	6.3	100	61	115	30	20	Rp 3/4"	>50	1.3
21151300	VLA131	25	10	115	65	119	34	20	Rp 1"	>50	1.5
21151400	VLA131	32	16	130	70	120	35	20	Rp 1 1/4"	>50	2.1
21151500	VLA131	40	25	150	74	128	42	20	Rp 1 1/2"	>50	3.0
21151600	VLA131	50	38	180	90	138	53	20	Rp 2"	>50	4.7

\* Kvs-value in m<sup>3</sup>/h at a pressure drop of 1 bar.

# CONTROL VALVE PN16

## SERIE SERIE VLA100

### FLOW CHART

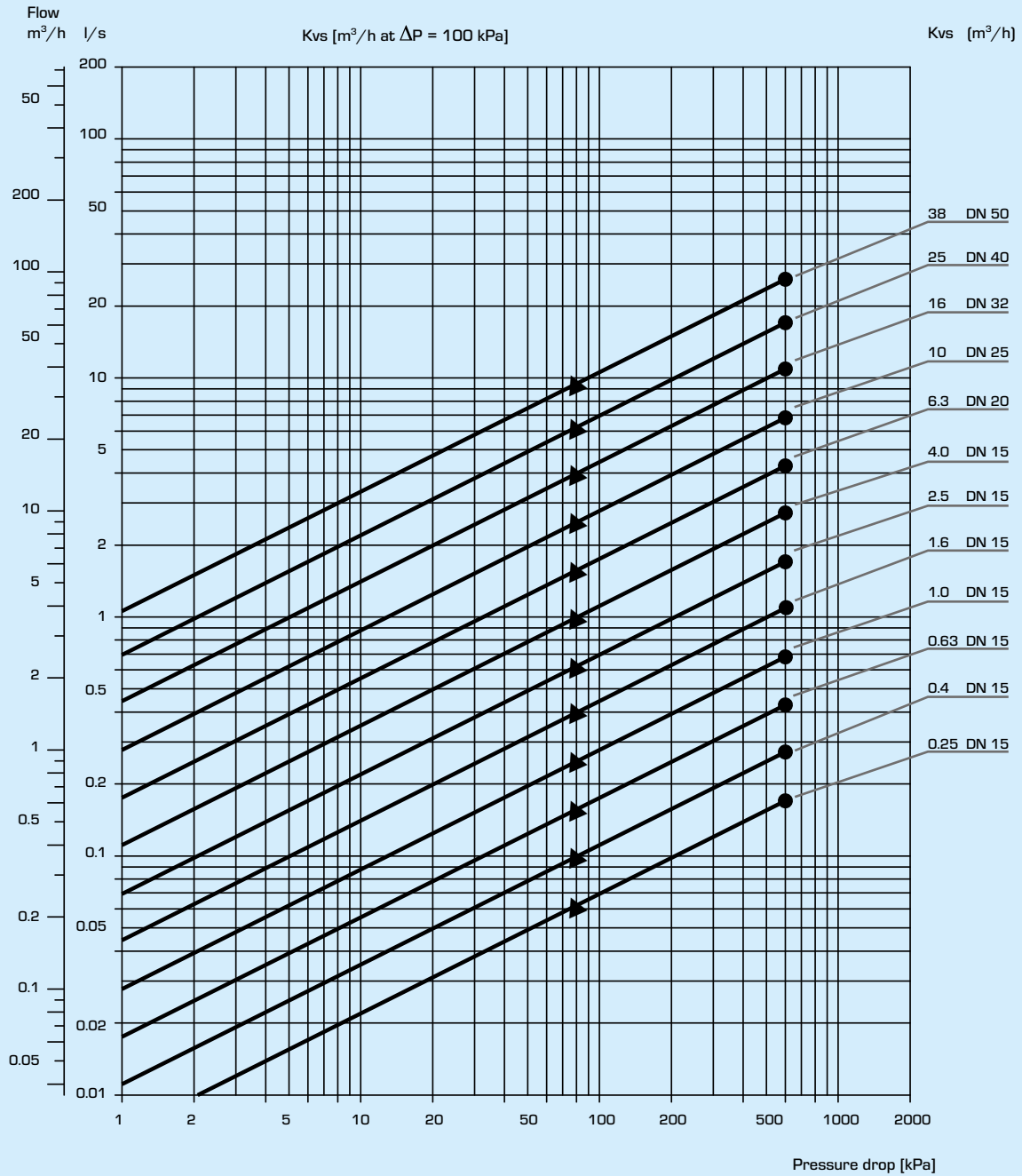

- = max differential pressure drop allowed in mixing function
- ▲ = max differential pressure drop allowed in diverting function

To be considered: As both the viscosity and the thermal conduction are affected when glycol is added to the system water, this fact has to be considered when dimensioning the valve. A good rule is to choose one size higher  $K_v$ -value when 30 - 50% glycol is added. A lower concentration of glycol may be disregarded. N.B.! Maximum 50% glycol for freezing protection and oxygen absorbing compounds are allowed as additives.

# CONTROL VALVE PN16

## SERIE SERIE VLA100

### INSTALLATION

The valve should be mounted with flow direction in accordance with the valve marking.

If possible, the valve should be installed in the return pipe, in order to avoid exposing the actuator to high temperatures.

The valve must not be installed with the actuator mounted below the valve.

#### Mounting positions:

A = Allowed mounting position with fluid temperature between -20°C to +120°C.

B = Allowed mounting position with fluid temperature between 0°C to +150°C.

C = Not allowed mounting position.

To ensure that suspended solids will not become jammed between the valve plug and seat, a filter should be installed upstream of the valve, and the pipe system should be flushed before the valve is installed.

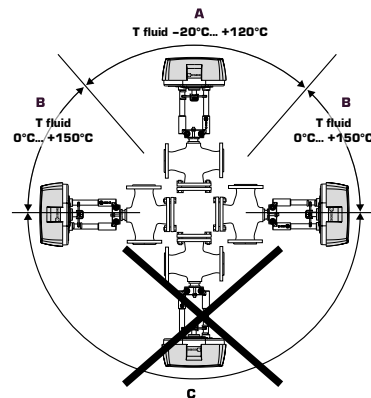

### VALVE AUTHORITY [β]

$\Delta p_v$  - pressure losses over the valve [bar]

$\Delta p_{sys}$  - pressure losses over the system with variable flow [bar]

$\Delta p_{inst}$  - pressure losses over the installation [bar]

Recommendation : Valve authority [β] shall be between 0.3 to 0.7

#### a) 2-way valve

$$\beta = \frac{\Delta p_v}{\Delta p_v + \Delta p_{inst}}$$

#### b) 3-way valve

$$\beta = \frac{\Delta p_v}{\Delta p_v + \Delta p_{sys}}$$

### INSTALLATION EXAMPLES

#### 2-WAY CONTROL VALVES



Installation without local circulating pump



Installation with local circulating pump

#### 3-WAY CONTROL VALVES

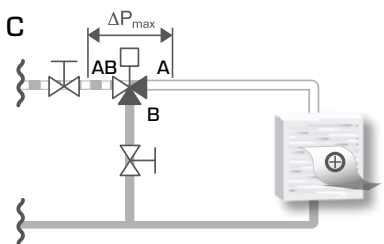

Circuit without local circulation pump

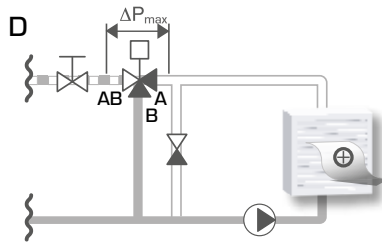

Circuit with local circulation pump

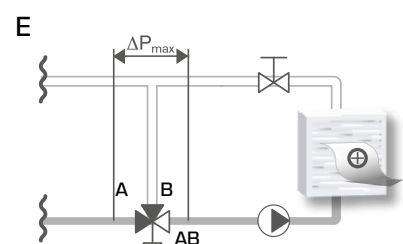

Circuit with local circulating pump